

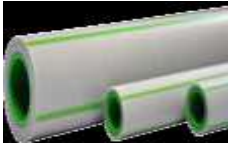
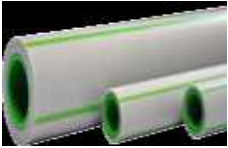

Вид продукції	діаметр	ціна \$		КОЛ-ВО ЯЩ.	КОЛ-ВО УП.	Вид продукції	діаметр	ціна \$		КОЛ-ВО ЯЩ.	КОЛ-ВО УП.
---------------	---------	---------	--	------------	------------	---------------	---------	---------	--	------------	------------

Труби ПП-Р

	PN 16	20*2,8	0,501		100	4
		25*3,5	0,802		60	4
		32*4,5	1,303		40	4
		40*5,6	1,918		24	4
		50*6,9	3,293		16	4
		63*8,7	5,741		12	4
		75*10,4	8,890		8	4
		90*12,5	11,739		4	4
	110*15,2	18,898		4	4	
PN 10	160*14,6	30,000				

	PN 20	20*3,4	0,515		100	4
		25*4,2	0,916		60	4
		32*5,4	1,575		40	4
		40*6,7	2,291		24	4
		50*8,4	3,579		16	4
		63*10,5	5,741		12	4
		75*12,5	8,876		8	4
		90*15	12,026		4	4
	110*18,4	18,898		4	4	
	160*26,6	56,818				

	PN 20 Faser	20*3,4	0,716		100	4
		25*4,2	1,088		60	4
		32*5,4	1,775		40	4
		40*6,7	2,806		24	4
		50*8,3	4,309		16	4
		63*10,5	6,872		12	4
		75*12,5	9,878		8	4
		90*15	14,603		4	4
	110*18,3	21,489		4	4	

	Труба ASG Nano Ag композит	20*3,2	1,059		100	4
		25*4,2	1,589		60	4
		32*4,5	2,434		40	4
		40*5,6	4,009		24	4
		50*6,1	5,512		16	4
		63*7,8	9,227		12	4
		75*9,5	13,028		8	4

Цельнопластикові фітінги

	Коліно 45 *	20	0,079		400	50
		25	0,142		200	25
		32	0,309		80	10
		40	0,600		60	10
		50	0,890		32	4
		63	1,513		21	3
		75	3,275		2	2
		90	4,297		1	1
		110	8,027		1	1
	160	20,050		1	1	

	Коліно 45° внутрішнє/наружнє	20	0,134			

	Перекрещення	20	0,491		100	
		25	0,787		50	
		32	1,220		35	
		40	1,710		10	

	Обвід 90°	20	0,320		120	10
		25	0,516		80	10
		32	1,103		40	10

	Компенсуюча петля	20	1,875		5	
		25	2,857		5	
		32	4,879			
		40	6,928		2	

	Монтажна планка		1,153			

Вид продукції	діаметр	ціна ,реком \$	ціна, \$	кол-во ящ.	кол-во уп.
---------------	---------	----------------	----------	------------	------------

	20	0,079		300	50
	25	0,142		150	25
	32	0,285		80	10
	40	0,680		40	4
	50	0,883			8
	63	1,550		12	2
	75	3,623		8	1
	90	5,514		6	1
	110	10,880		1	1
	160	24,190		1	1

	25*20	0,134		400	50
	32*20	0,156		300	30
	32*25	0,161		200	10
	40*20	0,202		180	10
	40*25	0,202		180	10
	40*32	0,252		120	10
	50*20	0,383			10
	50*25	0,383			10
	50*32	0,383		80	10
	50*40	0,417			10
	63*20	0,672			
	63*25	0,672			
	63*32	0,699			
	63*40	0,699			
	63*50	0,699			
	75*20	1,445			
	75*25	1,445			
	75*32	1,506			
	75*40	1,343			
	75*50	1,678			
	75*63	1,678			
	90*32	2,409			
	90*40	1,790			
	90*50	1,790			
	90*63	1,790			
	90*75	1,790			
	110*40	5,541			
	110*50	5,594			
110*63	5,594				
110*75	5,594				
110*90	5,594				

	20	0,063		400	50
	25	0,101		200	25
	32	0,191		100	10
	40	0,410		100	10
	50	0,568		50	5
	63	0,924			
	75	1,781			
	90	2,456		10	2
	110	5,549			
	160	12,289			

Вид продукції	діаметр	ціна ,реком \$	ціна, \$	кол-во ящ.	кол-во уп.
---------------	---------	----------------	----------	------------	------------

	25*20	0,231		100	10
	32*20	0,316		100	10
	32*25	0,444		100	10

	20	0,145		400	50
	25	0,241		200	
	32	0,494		100	

	25*20	0,103		300	50
	32*20	0,143		180	10
	32*25	0,182		150	10
	40*20	0,232		140	10
	40*25	0,232		140	10
	40*32	0,250			10
	50*20	0,428		80	5
	50*25	0,428		80	5
	50*32	0,428		80	5
	50*40	0,445		56	4
	63*20	0,645			
	63*25	0,680			
	63*32	0,700			
	63*40	0,715			
	63*50	0,730			
	75*20	1,253			
	75*25	1,259			
	75*32	1,408			
	75*40	1,408			
	75*50	1,724			
	75*63	1,724			
	90*32	2,216			
	90*40	1,894			
	90*50	1,894			
	90*63	1,894			
	90*75	1,894			
	110*40	4,119			
	110*50	5,967			
	110*63	5,967		10	2
	110*75	5,967			
	110*90	5,967			

	20	0,102		160	20
	25	0,191		120	20
	32	0,370		60	10
	40	0,570		56	2
	50	1,150		24	2
	63	2,050		15	1
	75	4,711		8	1
	90	7,021			1
	110	12,328			
	160	24,590			

Вид продукції	діаметр	ціна \$	КОЛ-ВО ЯЩ.	КОЛ-ВО УП.
Вваре сідло	63*32	0,441	120	
	75*32	0,568	120	
	90*32	0,771	120	
	110*32	1,180	120	

Вид продукції	діаметр	ціна ,реком \$	КОЛ-ВО ЯЩ.	КОЛ-ВО УП.
Різьбове з'єднання (американка)	20	0,378		10
	25	0,548		5
	32	0,910		4
	40	1,556		2

Пробка с резьбою	1/2"	0,087	400	50
	1/2"Л	0,235	120	10
	3/4"	0,105		
	3/4"Л	0,241		
	1"	0,124		
	5/4"	0,181		

Заглушка	20	0,069	400	20
	25	0,112	300	20
	32	0,191	120	10
	40	0,206	120	10
	50	0,465	80	4
	63	0,893		
	75	1,220		
	90	2,300		
	110	4,577		

Трійник редуцирований	25*20*25	0,175	120	20
	32*20*32	0,310	90	10
	32*25*32	0,313	80	10
	40*20*40	0,430		
	40*25*40	0,620	50	10
	40*32*40	0,445	50	10
	50*20*50	0,773	40	8
	50*25*50	0,773	40	4
	50*32*50	0,840		
	50*40*50	0,950	32	2
	63*20*63	1,288		
	63*25*63	1,288		
	63*32*63	1,288		
	63*40*63	1,288	10	2
	63*50*63	1,790		1

Трійник редуцирований	75*20*75	4,818		
	75*25*75	4,818	15	3
	75*32*75	5,421		
	75*40*75	5,421		
	75*50*75	5,421		
	75*63*75	5,421	9	1
	90*32*90	7,227	6	1
	90*40*90	12,320		1
	90*50*90	12,320		
	90*63*90	12,320		
	90*75*90	12,320		
	110*40*110	14,454		
	110*50*110	14,454		
	110*63*110	16,452		
	110*75*110	16,452		
	110*90*110	16,452	4	1

Тройне коліно	20	0,220	200	20
	25	0,422	120	10

Хрест	20	0,153	100	10
	25	0,283	100	10
	32	0,504	60	10
	40	0,964	40	5
	50	2,397	22	
	63	3,730	9	3

Комбіновані фітинги

Перехідник з метал. резьбою НАРУЖНОЮ	20 × 1/2"	0,831	180	10
	20 × 3/4"	1,367	80	10
	25 × 1/2"	0,934	80	10
	25 × 3/4"	1,308	120	10
	32 × 1/2"	1,089	80	10
	32 × 3/4"	1,566	80	10
	32 × 1"	2,603	70	5
	40 × 5/4"	5,327	40	4
	50 × 6/4"	6,248	20	4
	63 × 2"	10,585	12	1
	75 × 2,5"	19,950		
	90 × 3"	38,544		
	110 × 4"	72,270		

Перехідник з метал. резьбою ВНУТРІШНЬОЮ	20 × 1/2"	0,650	150	10
	20 × 3/4"	0,894	120	10
	25 × 1/2"	0,702	100	10
	25 × 3/4"	1,102	120	10
	32 × 1/2"	1,084	120	10
	32 × 3/4"	1,076	120	10
	32 × 1"	2,259	60	10
	40 × 5/4"	5,300	40	5
	50 × 6/4"	5,131	15	
	63 × 2"	7,347		
	75 × 2,5"	18,067	10	1
	90 × 3"	33,726		
	110 × 4"	72,270		

Вид продукції	діаметр	ціна , \$		КОЛ-ВО ЯЩ.	КОЛ-ВО УП.
Настінне коліно з метал. різьбою внутрішньою	20 × 1/2"	0,685		100	10
	25 × 1/2"	1,084		100	10
	25 × 3/4"	1,771		80	10

Коліно з метал. різьбою внутрішньою	20 × 1/2"	0,702		100	10
	20 × 3/4"	1,033		100	10
	25 × 1/2"	0,858		80	10
	25 × 3/4"	1,124		80	10
	32 × 1/2"	1,349		60	10
	32 × 3/4"	1,561		60	10
	32 × 1"	2,187		40	10
	40 × 5/4"	5,798		32	2

Трійник с метал. різьбою внутрішньою	20 × 1/2"	0,756		100	10
	20 × 3/4"	1,138		100	10
	25 × 1/2"	0,794		80	10
	25 × 3/4"	1,175			10
	32 × 1/2"	1,561		60	10
	32 × 3/4"	1,807		60	10
	32 × 1"	2,486		40	5
	40 × 5/4"	6,564		24	2

Патрубок с накидною гайкою	20 × 1/2"	1,910		300	25
	20 × 3/4"	2,363			
	25 × 1/2"	2,450			
	25 × 1"	3,509			
	25 × 3/4"	2,46			
	32 × 1"	2,42			

Розбірне з'єднання внутрішнє	20	2,409		120	10
	25	2,770		80	5
	32	4,336		60	4
	40	6,745		40	2
	50	11,804		24	2
	63	14,574		13	1

Вид продукції	діаметр	ціна , \$		КОЛ-ВО ЯЩ.	КОЛ-ВО УП.
Настінне коліно з метал. різьбою наружньою	20 × 1/2"	1,171		100	10
	25 × 1/2"	1,180		80	10
	25 × 3/4"	1,819		60	10

Коліно з метал. різьбою наружньою	20 × 1/2"	0,831		100	10
	20 × 3/4"	1,401		60	10
	25 × 1/2"	0,893		100	10
	25 × 3/4"	1,299		80	10
	32 × 1/2"	1,494		60	10
	32 × 3/4"	1,939		60	10
	32 × 1"	2,877		40	5

Трійник с метал. різьбою наружньою	20 × 1/2"	0,838		100	10
	20 × 3/4"	1,411		100	10
	25 × 1/2"	0,831		60	10
	25 × 3/4"	1,461		50	10
	32 × 1/2"	1,566		60	10
	32 × 3/4"	1,795		60	10
	32 × 1"	2,598			5
	40 × 5/4"	6,951		20	2

Коліно 90° с накидною гайкою (перехід пласт. с накидною гайкою)	20 × 1/2"	1,512			25
	20 × 3/4"	1,260			
	25 × 3/4"	1,622			20

Розбірне з'єднання труба-труба	20	2,263			
	25	3,552			
	32	4,527			4
	40	9,240			1
	50	13,460			

Фальцевий бурт	40	1,288			
	50	1,892			
	63	3,162			

Вид продукції	діаметр	ціна , \$		КОЛ-ВО ЯЩ.	КОЛ-ВО УП.
Американка зовнішня	20 × 1/2"	2,050		180	10
	25 × 3/4"	2,988		80	8
	32 × 1"	4,007		68	4
	40 × 5/4"	6,298		48	2
	50 × 6/4"	10,757		28	1
	63 × 2"	17,200		12	1

Вид продукції	діаметр	ціна , \$		КОЛ-ВО ЯЩ.	КОЛ-ВО УП.
Американка внутрішня	20 × 1/2"	1,830		180	10
	25 × 3/4"	2,683		90	5
	32 × 1"	3,774		84	4
	40 × 5/4"	5,796		48	2
	50 × 6/4"	8,471		2	2
	63 × 2"	15,200		1	1

Настінний комплект (подвійне настінне коліно)	2*20*1/2"	2,988		14	2
					

Настінне коліно подвійне для кранів (зміщувачів)	20*1/2"	2,557		36	2
					

Вентиль пластиковий / шаровий

Вентиль-клапан пластиковий шаровий з латунним шариком	20 б	1,811		60	10
	25 p	2,677		56	2
	32 p	4,488		22	2
	40 p	7,007		20	1
	50 p	10,645		10	1
	63 p	20,000		6	1
	75 p	33,850			

Вентиль -клапан пластиковий шаровий з пластиковим шариком	20 p	1,192		100	10
	25 p	1,421		70	2
	32 p	2,340		36	2
	40 p	3,469		20	2
	50 p	6,010			
	63 p	9,588			

Вентиль прямооточний пластиковий (клапан прямооточний)	20	3,388		60	
	25	3,976		40	2
	32	6,685		28	2
	40	11,220			
	50	16,650			
	63	26,030			

Вентилья радіаторні

Вентиль радіаторний прямий з резинкою	20	3,900		48	4
	25	4,095		48	4

Вентиль радіаторний угловий з резинкою	20	3,900		48	4
	25	4,095		48	4

Вид продукції	діаметр	ціна , \$		КОЛ-ВО ЯЩ.	КОЛ-ВО УП.
Кран термостатичний прямий	20 × 1/2"	5,700		60	4
	25 × 3/4"	6,100		48	4

Вид продукції	діаметр	ціна , \$		КОЛ-ВО ЯЩ.	КОЛ-ВО УП.
Кран термостатичний угловий	20 × 1/2"	5,700		60	4
	25 × 3/4"	6,100		48	4

Вентилі латунні

Вид продукції	діаметр	ціна , \$		КОЛ-ВО ЯЩ.	КОЛ-ВО УП.
Вентиль шаровий латунний с МРВ	20 × 1/2"	5,059		72	1
	25 × 3/4"	7,046			1
	32 × 1"	11,647		24	1

Вид продукції	діаметр	ціна ,реком \$		КОЛ-ВО ЯЩ.	КОЛ-ВО УП.
Вентиль шаровий латунний с МРН	20 × 1/2"	5,878		72	1
	25 × 3/4"	7,709		48	1
	32 × 1"	13,370		24	1

Кріплення та опори

Зажим ПП	20	0,036		1000	50
	25	0,043		800	50
	32	0,071		1000	50



Подвійний зажим	2*20	0,094			50
	2*25	0,134		600	50

Зажим з лентою	40	0,125		500	50
	50	0,285			50
	63	0,359		150	25
	75	1,56			

Комплект / Паяльник

Паяльник ASG-PLAST 1500BT 63-A7					
		47		1	1

Паяльник ASG-PLAST 800BT 32-тт					
		29		1	1

Ножиці для PPR труб					
	16-32	3,35		1	1
	16-40	7,02		1	1

Насадки парні до 63-A7	20				1	1
	25				1	1
	32				1	1
	40				1	1
	50				1	1
	63				1	1